

MANN + HUMMEL

TRI-KLEEN 500 UV BR PORTABLE AIR FILTRATION UNITS



INSTRUCTION MANUAL

Mann+Hummel Ltda.
Alameda Filtros Mann 555
Indaiatuba - São Paulo – Brazil
(19) 3894-9400
www.mann-hummel.com

TRI-KLEEN 500 UV BR

2020.03.27

READ AND SAVE THESE INSTRUCTIONS!

Notes:

1. Read and understand all operating instructions before using the Portable Air Filtration Unit.
2. Save this manual for future reference.

This instruction manual provides important information on the installation and operation of the TRI-KLEEN 500UV BR portable room air filtration units. These instructions must be carefully followed in order to operate the units safely and correctly. If you have any questions regarding the use or care of this equipment, please contact Mann+Hummel by means of the SAC (Customer Attendance Service) by phone 0-800-701-6266.

Mann+Hummel strongly recommends users of the room air filtration units and accessories to follow the most recent guidelines and/or standards published by the Occupational Safety and Health Administration, Centers for Disease Control and Prevention, Environmental Protection Agency, Refrigerating and Air Conditioning Engineers, and all other federal, state, and municipal regulations.

Contents

SAFETY INSTRUCTIONS	1
REQUIREMENTS FOR SAFE OPERATION	1
IMPORTANT SAFETY INSTRUCTIONS	1
GENERAL INFORMATION	2
HOW TO DETERMINE THE REQUIRED NUMBER OF AIR FILTRATION DEVICES (AFD).....	3
ELECTRICAL REQUIREMENTS	4
KEY COMPONENTS	4
KEY COMPONENT DESCRIPTIONS.....	5
OPERATING THE UNIT.....	6
BEFORE OPERATING THE UNIT	6
LOCATION OF THE UNITS AND MODES OF OPERATION.....	6
CONTROL PANEL OPERATION.....	7
USER SERVICING INSTRUCTIONS	13
FILTER REPLACEMENT	13
FILTER REPLACEMENT PROCEDURE.....	14
COMPONENT REPLACEMENT AND CARE OF THE UNIT.....	15
TRI-KLEEN 500UV BR SERIES SPECIFICATIONS.....	15
TROUBLESHOOTING GUIDE	16
LIMITED WARRANTY.....	17
TRI KLEEN 500UV SERIES PARTS LIST.....	19

SAFETY INSTRUCTIONS

REQUIREMENTS FOR SAFE OPERATION

1. Never allow unauthorized individuals or children to operate the unit at any time.
2. Mann+Hummel recommends anyone operating TRI-KLEEN units to wear the proper personal protective equipment (PPEs) and follow safe work practices in accordance with federal, state, municipal and employer regulations.
3. Check the condition of power cord(s) before using them. Damaged cords can cause fatal electric shock and/or motorized impeller failure.
4. Power cord(s) should never be exposed to water, heat, and/or sharp or abrasive objects. In addition, they should never be kinked or crushed. Avoid tightly wrapping the cords to prevent kinking of the internal wires. Replace always damaged power cords immediately.
5. Never pull the unit by the power cord.
6. Avoid running over power cords with utility equipment and vehicles.

If the equipment is used in a manner not specified by the manufacturer, the protection provided by the equipment may be impaired.

IMPORTANT SAFETY INSTRUCTIONS

- a. Do not operate any unit with a damaged cord or plug. Discard unit or return it to an authorized service facility for examination and/or repair.
- b. Do not run cord under carpeting. Do not cover cord with throw rugs, runners, or similar coverings. Do not route cord under furniture or appliances. Arrange cord away from traffic area and where it will not be tripped over.

Caution: As with any piece of electrical equipment, always make sure that the unit is turned “OFF” before connecting the power cord to an electrical outlet or disconnecting it from an electrical outlet. Failure to do so will cause “arcing”, and could result in personal injury, fire hazards and/or damage to the unit. Do not disconnect the power cord from supply receptacle while the unit is operating.

Warning: To reduce risk of electrical shock, do not expose this unit to water or rain. Do not touch the electrical outlet or power cord(s) with wet hands or while standing on a wet or damp surface.

Warning: Risk of electrical shock! It can cause injury or death! Turn unit “OFF” and disconnect power cord from supply receptacle before replacing the HEPA filter and before cleaning or servicing the unit.

Warning: To reduce the risk of fire, electric shock, or injury to person observe the following: Use this unit only in the manner intended by Mann+Hummel. If you have questions, please contact Mann+Hummel by means of the SAC (Customer Attendance Service) by phone 0-800-701-6266.

Warning: To reduce risk of fire or electrical shock, do not use this unit with any solid-state speed control device.

Caution: This unit is only designed for indoor use.

Caution: Use it only for General Ventilating. Do Not Use To Exhaust Hazardous or Explosive Materials And Vapors.

Warning: Mann+Hummel air filtration systems are not intrinsically safe for use in hazardous environments. Consult always a certified industrial hygiene specialist before using them. Do NOT use this equipment in any atmosphere that is or may be immediately dangerous to life or health (IDLH), combustible, flammable, explosive, oxygen deficient and/or contains odors, vapors, gases or particulates that exceed permissible exposure levels. Such

atmospheres may require the use of intrinsically safe equipment, specific engineering controls, and personal protective equipment (PPEs) in accordance with Occupational Safety and Health Administration (OSHA), Environmental Protection Agency (EPA), and other federal, state, provincial and local regulations.

GENERAL INFORMATION

The TRI-KLEEN portable air filtration units incorporate the HEPA (High Efficiency Particulate Air) filtration which provides the most effective available mechanical filtration method. In addition to providing HEPA filtration, the units are primarily used in a negative pressure or recirculation mode. A negative pressure condition is created in order to confine contaminated airborne particles. This condition exists when the static pressure inside the room containing the unit(s) is lower in relation to the pressure of the environment outside the room. The static pressure differential is created and maintained by continuously exhausting air out of a given room at a faster rate than air enters the room from all other sources. In the recirculation mode, all or part of the filtered air is exhausted back into the room containing the unit.

The TRI-KLEEN portable air filtration units can be used to create a positive pressure condition by directing filtered exhaust air from the units to another area of the facility via rigid or flexible ducting; however, this is not their primary application. A positive pressure condition exists when the static pressure in a given room is higher relative to the pressure of the environment outside the room. The static pressure differential is created and maintained by continuously delivering air into a given room at a faster rate than air is exhausted from the room.

TRI-KLEEN 500UV BR includes four ultraviolet germicidal irradiation UVGI (hereinafter referred to as UV) lamps that irradiate the air flowing through the unit. The lamp is affixed to the inside of the HEPA filter base and emits germicidal ultraviolet light that inhibits the growth of bacteria and viruses. UV capability can only be integrated by the factory at the time of order and it cannot be added after the machine is manufactured.

STANDARD AIR FILTER STAGES (SUPPLIED WITH THE UNIT)

TRI-KLEEN units come equipped with one pre-filter mounted in the pre-filter compartment and a final stage HEPA filter, located inside the cabinet:

- 2" deep, pleated pre-filter treated with an EPA registered antimicrobial agent.
- HEPA filter is tested & certified to capture at least 99.97% (9,997 out of 10,000) 0.3-micron particles.
- HEPA filter is tested & certified to capture at least 99.97% (9,997 out of 10,000) 0.3micron particles. Includes integrated UV bulb.

Note: The particulate filters included with this unit do not remove odors, vapors or gases, including volatile organic compounds.

ALTERNATIVE FILTER (PURCHASED SEPARATELY)

Pleated, high-capacity, carbon filters are available for capturing OVG. These 2"-deep filters can be used as a pre-filter to reduce airborne OVG by chemically bonding the OVG molecules to the surface area of the carbon granules via a process known as adsorption. The carbon filters also provide a similar level of particulate filtration efficiency to the antimicrobial pre-filters.

Effective carbon adsorption is dependent upon the amount of carbon and exposed carbon granule surfaces, and the dwell (contact) time the OVG molecules have with the carbon granules. Operating the unit at lower speed settings to increase dwell time can therefore improve OVG adsorption, though it is highly unlikely that all of the OVG will be removed in one pass of air through the unit. Operating the unit in the recirculation mode can increase effectiveness, by exposing OVG particles to multiple passes through the carbon filter.

It is almost impossible to provide accurate estimates to two commonly asked questions: "how much time will it take to capture all of the OVG?", and "how do I know when a carbon filter should be replaced?" Unfortunately, unknown factors – such as concentration levels, fresh-air intake volume, temperature, and humidity – prevent establishment of any more accurate 'rule of thumb' than one's sense of smell. Since off-gassing of adsorbed OVG can occur when the adsorption capacity of the filter is reached, replace the carbon filter as soon as odor breakthrough is sensed.

HOW TO DETERMINE THE REQUIRED NUMBER OF AIR FILTRATION DEVICES (AFD)

1. Calculate the total air volume (V) in cubic feet (ft³) within the enclosed containment area by multiplying the length (L) x the width (W) x the height (H), all in feet ($V = L \times W \times H$).
2. Determine the minimum number of air changes per hour (ACH) specification. When no ACH number is specified, most users target at least 12 ACH for health care applications areas. A good practice is to build in a safety factor to compensate for filter loading, ducting losses, reduced voltage, and other factors that can reduce actual installed airflow. For example, if 12 ACH is the objective, enter 15 ACH for a 25% safety factor, enter 18 ACH for a 50% safety factor, or enter 21 for a 75% safety factor.
3. Determine the total number of AFD required using the following formula: $\text{Quantity} = (V \times \text{Design ACH}) / (\text{AFD Rating} \times 60)$
4. Always round up to the next whole number. For example, if the total number of AFD required is 1.32, two units are recommended, not one.

Example: How many TRI-KLEEN 500 (each with 500 CFM rated airflow or 800 m³/h) would be required to provide FS (a safety factor) in a 6x5x2,5 containment area?

1. $V = 6,096 \times 4,57 \times 2,44 \text{ m} = 2400\text{m}^3$
2. FS = 10 ~12 for hospitals and clinics and 5 ~6 for other locations

3. Quantity of AFD required = $(75 \text{ m}^3 \times 12) / (800 \text{ m}^3/\text{h}) = 900/800 = 1.2$ units
4. 1.2 units → 2 units required.

ELECTRICAL REQUIREMENTS

1. The units require a minimum of 110 or 220 volts AC, 60 Hz to operate properly; however, maximum air flow performance requires 110 or 220 volts AC, 60 Hz. (unique voltage requested on purchase).
2. Due to momentary start-up current surge, the unit requires a 15 amp circuit that is free of other loads.
3. Extension cords used for this unit must be listed, heavy duty industrial grade 3-wire type and be equipped with hospital grade plugs (if used in a health care facility). Use of larger numerical gauge (lower capacity wire) power cord(s) may result in electrical shock, fire hazards and/or damage to unit. The cord(s) must be in good condition and in continuous lengths (no splicing) and should not exceed a total of 5 m., in length. Make sure that any extension cords used do not reduce power to the unit to less than 110 or 220 volts. Use of a voltmeter to confirm adequate voltage is recommended.
4. Check to ensure that any circuit to which the unit is connected is protected by a 15 amp circuit breaker. The unit itself is equipped with a 5 amp circuit breaker.
5. The units should be connected to a three-prong, properly grounded electrical outlet.
6. To avoid personal injury, fire hazards and/or damage to the unit's electrical system and power cord, do not connect or disconnect the power cord to an electrical outlet unless the unit is switched to the "OFF" position.

KEY COMPONENTS

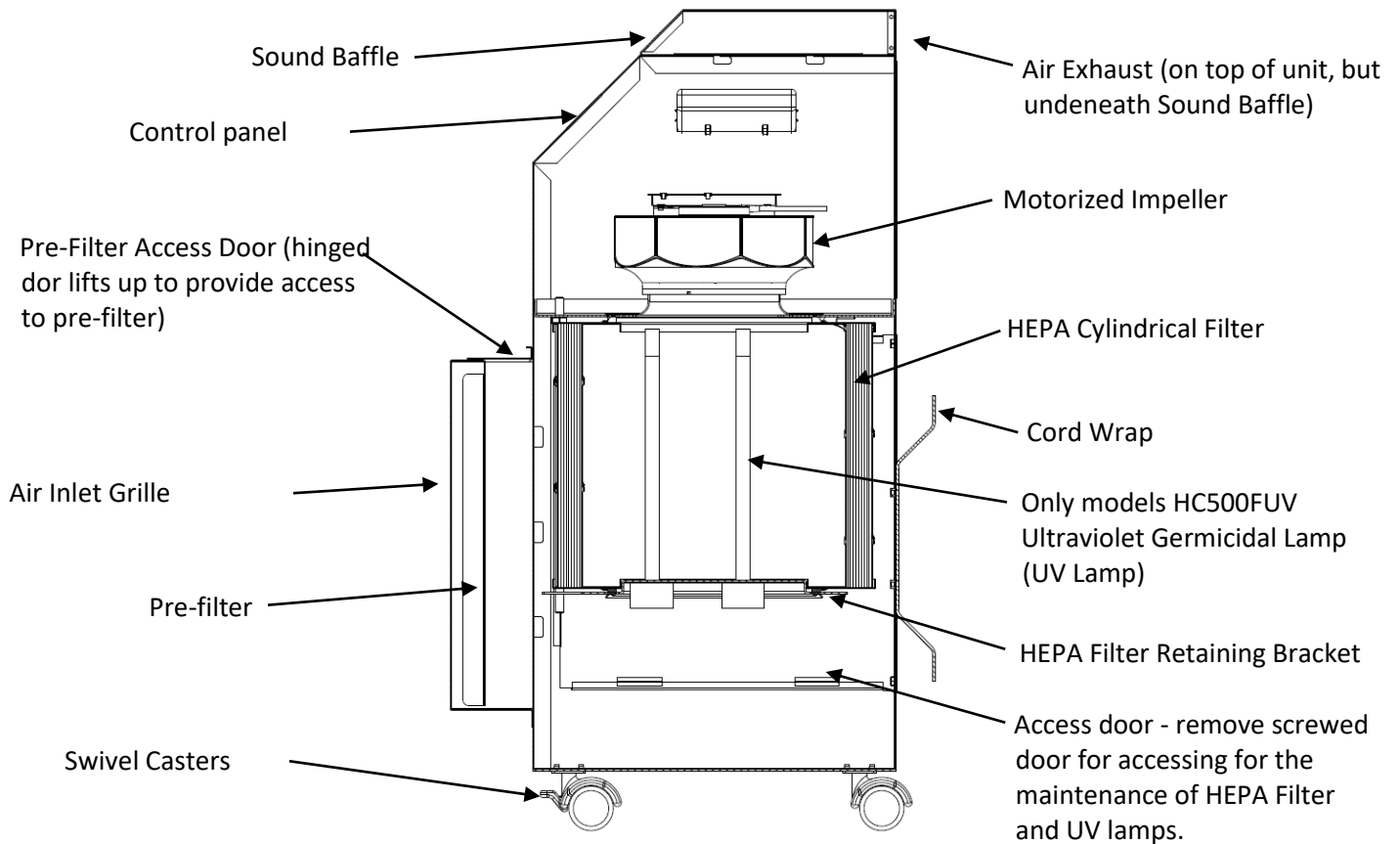

Models of TRI-KLEEN 500UV BR series - side view showing internal components

KEY COMPONENT DESCRIPTIONS

- **Pre-filter.** A pleated particulate filter that protects and extends the life of the more expensive HEPA filter. The pre-filter for this unit has an ASHRAE MERV 8 rating.
- **Alternative pre-filter** (must be purchased separately). Carbon pre-filter for capturing low concentrations of odors, vapors, gases and volatile organic compounds, collectively known as OVG, is also available. Carbon filters reduce airborne OVG by chemically bonding the OVG molecules to the surface area of the carbon granules, via a process known as adsorption. This filter can be used in the TRI-KLEEN unit instead of the standard pleated pre-filter. Note that the standard pre-filter does not capture odors.
- **HEPA Filter (non-UV models).** The cylindrical HEPA filter is individually tested and certified to ensure it provides a minimum efficiency rating of 99.97% when challenged with a 0.3 micron test aerosol at the unit's maximum air flow rate. This filter has a continuous foam gasket on one end for sealing purposes.
- **HEPA Filter/UV Lamp Assembly (UV models only).** The UV models have the same HEPA filter as the non-UV models, but the HEPA filter for the UV models have UV lamp integrated into the center of the cylindrical HEPA filter. Since they are integrated, the lamp and filter must be changed at the same time.
- **Motorized Impeller.** The motorized impeller is what creates the air flow - it pulls the air through the pre-filter and the HEPA filter and pushes the air out of the unit's exhaust.
- **LCD (Liquid Cristal Display) Touch Screen Controls.** This unit comes equipped with a LCD touch screen that enables to set the speed of the device and view the operating status of the unit.
- **Pre-filter Access Door.** Hinged door that lifts up for quick access to the pre-filter.
- **Air Inlet Grille.** Air intake located on the front face of the unit.
- **Swivel Casters.** The swivel casters allow for the unit to be easily moved from one location to another. The front two casters are lockable so that the unit can be kept in position after placed in the desired location.
- **HEPA Filter Access Panel.** This access panel is located on the bottom of the unit and is secured with Philips head screws. This panel will need to be removed in order to change the HEPA filter (and UV lamp, if applicable).
- **HEPA filter retaining bracket.** This bracket secures the HEPA filter in place.
- **Cord wrap.** Wrap the cord around this fixture during transport or storage to ensure the cord does not get damaged or cause a trip hazard.
- **Air Exhaust.** A 12" x 8" (30.5 cm x 20.3 cm) exhaust grille is located on the top of the unit.
- **Sound Baffle.** This sound baffle is installed on top of the unit over the air exhaust at the factory and helps reduce noise in applications where the unit is used to recirculate the air. If the unit is used in negative/positive pressure applications, this baffle will need to be removed in order for ducting to be attached to the unit.

Important Note: Do not operate the unit TRI-KLEEN unless the pre-filter and HEPA filter are installed, and the lower cover of filter access and panel are in place and closed.

OPERATING THE UNIT

BEFORE OPERATING THE UNIT

Inspect and tighten any HEPA filter retaining nuts that may have loosened during transportation. Inspect the filters for any material or structural damage prior to use and replace any damaged filters before operating the unit. When removing any filters prior to operation, always put them back in place with the airflow indicator on the filter housing oriented in the proper direction (if applicable).

As with any air filtration system, external airflow losses not attributable to the air filtration unit will reduce the airflow of the system. The following recommendations can minimize airflow losses created by external static resistance.

1. Always use the minimum length of ducting possible with the fewest possible number of turns and bends.
2. Rigid metal ducting creates less turbulence and consequently less airflow loss than flexible ducting. Regardless of the type of ducting used, rigid, "sweep-type", radiused connections should be used for all turns and bends.
3. If flexible ducting is used, it must be kept as taut as possible to avoid flattening.
4. Louvers, dampers, and other external control devices should be sized to provide the equivalent open area to the cross-sectional area of the exhaust ducting.
5. For negative or positive pressure applications, the total volume of air supplied to the room must be lower than the volume of air exhausted by the air filtration unit. The minimum recommended differential is the greater of 100 CFM or 10%. Pressure levels should be continuously monitored. Note: If the air supply to the room is not controlled, sufficient negative or positive pressure might not be achieved.

LOCATION OF THE UNITS AND MODES OF OPERATION

The TRI-KLEEN portable air filtration units can be operated in the following modes:

1. **Negative pressure.** Unit is inside the containment room. All of the filtered air is exhausted to an external environment.
2. **Full in-room recirculation.** Unit is inside the containment room. All of the filtered air is recirculated back into the room through the exhaust outlet.
3. **Positive pressure.** While possible, the TRI-KLEEN 500UV BR was not designed for this purpose. The unit is *outside* the containment room. All of the filtered air is exhausted to the containment room and creates a positive pressure in that room.

TRI-KLEEN portable air filtration units should be positioned at a maximum distance from the main door to the room in which they are used. For negative or positive pressure applications, the units will have to be ducted in order to create the pressure differential. Before the unit can be ducted, the sound baffle attachment on the top of the unit must be removed by loosening the two screws inside the baffle, and sliding the baffle towards the back of the machine. After the baffle has been slid towards the back, lift up on the attachment to remove the baffle and expose the exhaust grille. After the baffle has been removed, ducting can be connected to the unit. The units can accept 12" x 8" (30.5 cm x 20.3 cm) rectangular ducting or an optional (not included with the unit) round exhaust collar that accepts 8" diameter rigid or flexible ducting is available. This optional exhaust collar fits over the exhaust grille on the unit and is secured by 4 screws.

If the room air filtration units are being used to create and maintain a negative or positive pressure condition, the pressure differential between the negative or positive room and the environment outside the room should be monitored with a calibrated instrument according to the requirements. A room pressure monitor should be utilized in order to ensure that requirements are being met.

Important Note:



Do not operate the unit TRI-KLEEN unless the pre-filter and HEPA filter are installed, and the filter access door and panel are in place and closed

CONTROL PANEL OPERATION

TRI-KLEEN 500UV BR series units are equipped with an LCD touch screen for controlling and viewing the status of the unit. Upon providing power to the unit, the LCD screen will turn on and show the Mann+Hummel logo, after touching the screen, the operator will be directed to the MAIN SCREEN.

If the unit has power and the screen is not illuminated, simply touch the LCD screen to bring up the MAIN SCREEN. Note that if no buttons have been pushed for 15 seconds, the LCD screen will go to the Mann+Hummel logo again.

MAIN SCREEN

When the TRI-KLEEN portable air filtration unit is put into service and connected to the appropriate power supply, the screen illuminates and displays the "Mann+Hummel" logo, informing that the equipment is being started.



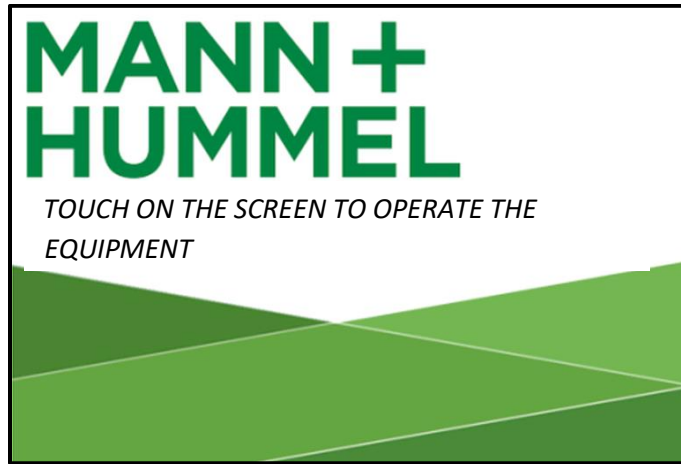

When in this screen, which we can name of "stand-by", the TRI-KLEEN equipment is already in function, where it will bring the previous settings, i.e., the same parameters of last time the equipment was under function and it was turned off. When it is the first time it is turned on, it will have the manufacturer's settings.





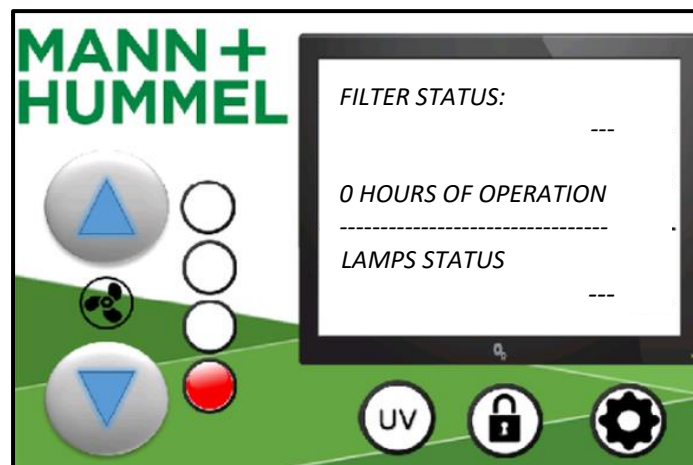

By touching on the equipment's LCD screen, we will go to the screen below with information about the filter status divided in 3 categories: **New** (cleaned filter, without accumulation of impurities), **Saturated** (the change of filter was made for some time and with considerable level of impurities retained, therefore it is a warning that the filter should be changed in order to avoid future damages to the equipment and ensure a good functioning) and **Critical** (when the allowed level of retained impurities is already exceeded and the filter has to be changed urgently), status of lamps which states, if the lamps are **OK** in order to be turned on, or if there is any irregularities the lamps will state as **N OK** (as for example a burned lamp), fan speed control, UV lamp ON/OFF, connectivity settings and element's change and screen locking.

Note: The equipment has an audible alarm which may occur in 3 different situations: N OK Lamp/ N OK Filter/ over 1500 h of operation. And that after corrective action of some mentioned situations; the equipment should have a normal function again.



	Increase the fan speed.
	Reduce the fan speed.

	Press the UV icon, in order to TURN the UV lamps ON.
	Press the UV icon, in order to TURN the UV lamps OFF.
	Lock the screen: Press the icon to lock the screen and return to the position <i>stand-by</i> .
	Settings: Connectivity and element's change.

FAN SPEED CONTROLS

The fan of the equipment TRI-KLEEN has 4 speed levels, where are represented by 4 circular indicators of the image below, the first at the bottom when it is signaled by the green color, it indicates that the equipment is in the minimum speed.

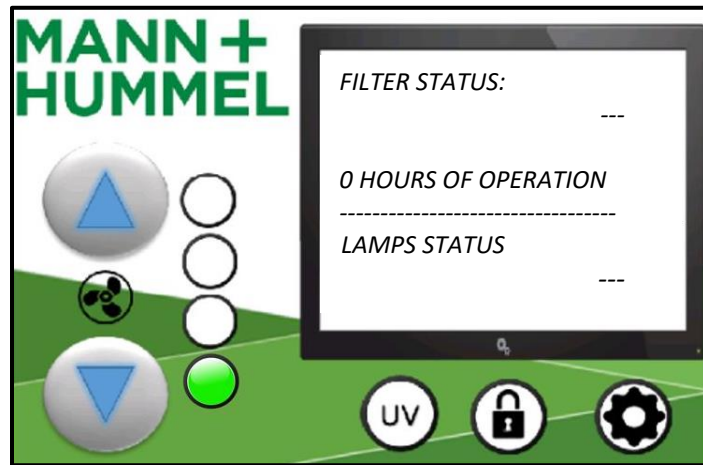

When the indicator at the top is signaled by the green color, it indicates that the equipment is in the maximum speed.

Note: It is recommended that the unit is operated always at the speed 4 (as shown in the figure below), in order to maximize the filtration, air changes and general operation conditions.

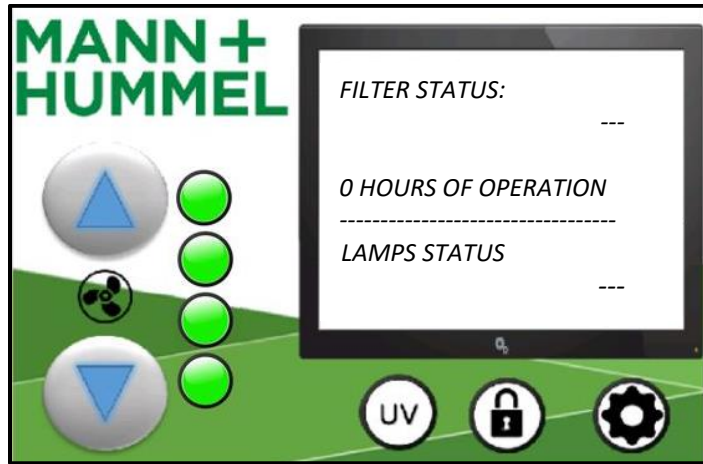

In order to turn the equipment's fan off, it is enough to reduce the speed until the first indicator (at the bottom), and following touch again the button Reduce, the fan will be turned off and it is signaled by the red color as shown below.

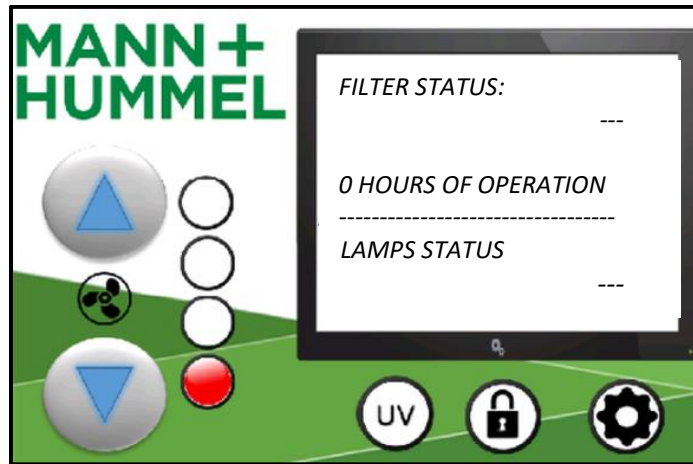

SETTINGS

By pressing the icon Settings, the equipment will make available two functions which are Operate via Wi-Fi and inform the element's change.

After changing the filters (for more details about change procedure, see pages from 13 to 15), the user should press the icon.

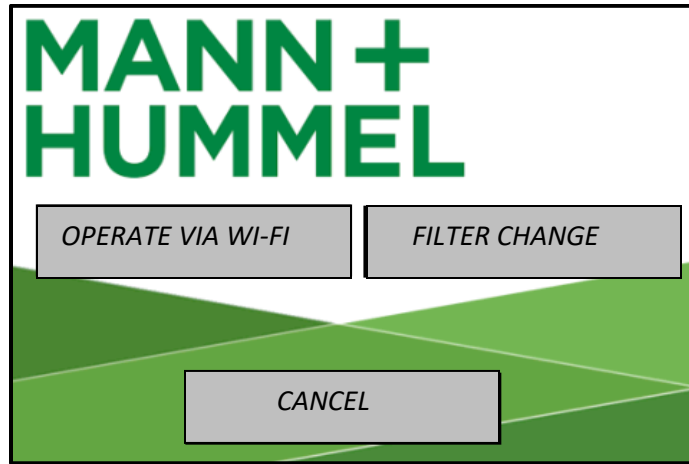

After pressing the function Filter change, the system will recognize that starting from that moment; the equipment will operate with new elements and with appropriate measurements of working hours and saturation level.



CONNECTIVITY

The equipment Tri-Kleen has available 2 different connectivity modes, via Bluetooth and via Wi-Fi.

The connection via Bluetooth may be done at any moment during the functioning of the Tri-Kleen, it is necessary that the user downloads the TRI-KLEEN application of MANN+HUMMEL, which is already in development in the Android and IOS versions.

After the user has paired via Bluetooth, the equipment's screen is inaccessible for the operation via *touch* (according to the image below), and it is exclusively operated via paired device, whether cell phone or computer.

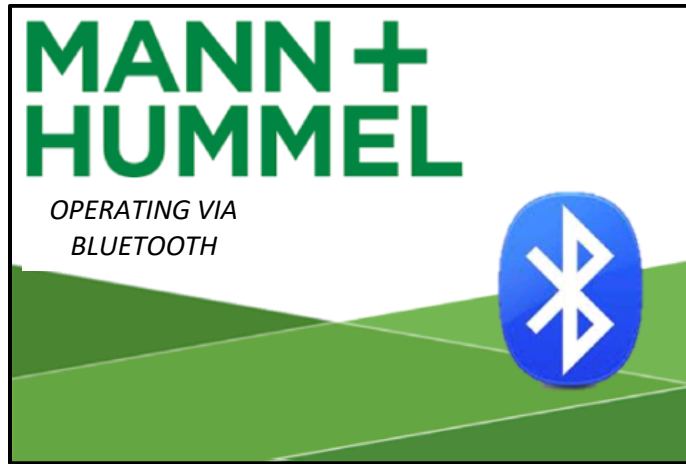

The connection via Wi-Fi should be started by the icon available in Settings.

Note: For more information, please contact Mann+Hummel by means of the SAC (Customer Attendance Service) by phone 0-800-701-6266.



After the user has paired via Wi-Fi, on the equipment's screen will be available only the function Stop Wi-Fi (according to the image below), the other functions will be operated via paired device, whether cell phone or computer

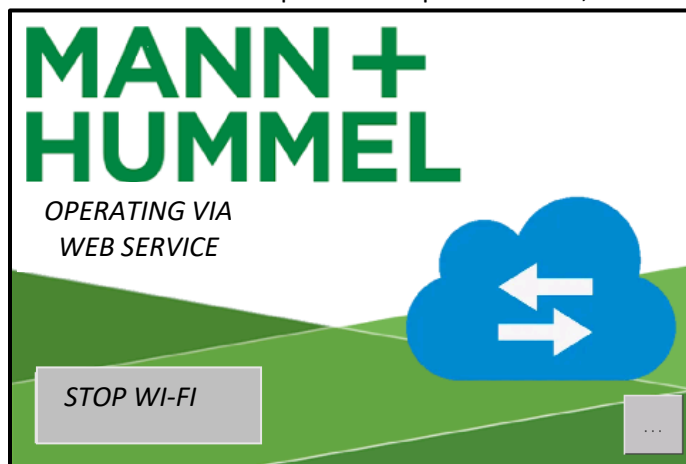

Note: If the room air filtration units are being used to create and maintain a negative or positive pressure condition, the pressure differential (between the room which has the unit and the environment outside the room) should be monitored with a calibrated instrument according to the requirements.

USER SERVICING INSTRUCTIONS

TRI-KLEEN portable air filtration units are designed to be low maintenance devices and basic maintenance should be performed as follows:

- Filters should be changed as needed based on the status indicated on the LCD touch screen. Follow the FILTER CHANGE PROCEDURE as described in this manual. Filters can be changed earlier, if desired, to maintain a minimum required flow rate.
- The unit should be cleaned with a damp cloth, water-based cleaner/sanitizer, or a germicidal or antimicrobial cleaning agent as needed. Do not use harsh chemicals, solvents or detergents to clean the unit.

Note: Mann+Hummel recommends that the HEPA filter be changed after 12 months, regardless of how little the unit may have been used, as a precautionary measure as some materials in the filter's construction can be affected over time.

Note: The HEPA filter/UV lamp assembly in UV models is supplied as a unit and must be replaced as such. The UV lamps have a rated service life of approximately 8,000 h, provided they are not turned "ON" and "OFF" several times a day. The UV lamps are permanently mounted inside the HEPA filter frame and they are not replaceable. Mann+Hummel recommends replacing the HEPA filter/UV lamp assembly at least every 12 months.

Warning: Keep electrical components dry as their exposure to liquids poses a safety hazard and can damage components.

FILTER REPLACEMENT



Note: Personnel responsible for changing filters, servicing units, or relocating units within the facility are urged to wear the proper personal protective equipment (PPEs) (mask, gloves, glasses and face shield) and follow safe work practices in accordance with federal, state, provincial, local, and employer regulations. Mann+Hummel cannot recommend the type of PPE required as that will need to be determined by safety/risk assessment personnel based on various risk factors, including the type of particulates being captured by the air filtration device and the surrounding environment where the units are being used, transported, or serviced.

Note: Filters being replaced must be disposed of in accordance with federal, state, municipal, local, and facility regulations.

System airflow reduction is generally the result of filter loading, blockage of the unit's inlet or outlet, or use of excessive lengths of flex duct that is connected to the outlet.

The size and concentration of airborne contaminants, temperature and humidity conditions, and duration of use determine how often filters need replacement.

If a carbon filter is being used instead of the pleated pre-filter, the method of determining when to replace the activated carbon filter is somewhat subjective when it comes to reducing odors. As the odor, vapor, and/or gas filtration capacity

decreases, the user will begin to sense a slight odor or taste of the contaminant, indicating that the filter should be replaced.

Caution: Room air filtration units are designed to meet or exceed standards for high efficiency air filtration equipment. Use only Mann+Hummel parts, including replacement filters. **Use of non Mann+Hummel parts and filters voids the product warranty and all performance claims.**

Warning: To reduce the risk of fire, electrical shock or personal injury, always turn the UV lamp switch "OFF" (TRI-KLEEN 500UV BR), turn the unit "OFF" and disconnect the power cord from supply receptacle before replacing the HEPA filter, HEPA filter/UV lamp assembly (TRI-KLEEN 500UV BR) and before cleaning or servicing the unit. The UV lamp produces intense ultraviolet light and heat. Direct contact with ultraviolet light and the lamp surface can cause temporary or permanent loss of vision and severe skin burns. Never look at a UV lamp while it is illuminated. Lamp must be "OFF" for at least 15 minutes before replacing the HEPA filter/UV lamp assembly, to allow the lamp to cool. Touching the lamp immediately after it is turned "OFF" will result in severe skin burns.



FILTER REPLACEMENT PROCEDURE

To change the pre-filter:

1. With the unit turned on and running at Speed 4, open the pre-filter door by swinging it upwards (refer to the key components section at the beginning of the manual to locate the pre-filter door).
2. Slide the pre-filter upwards to remove it from the pre-filter compartment.
3. Slide in a new pre-filter, making sure the air flow directional arrow is pointing towards the machine and that the pleats on the filter are oriented vertically

4. Close the pre-filter door.

To change the HEPA filter (and UV lamps):

Important note: The HEPA filter/UV lamp assembly in UV models is supplied as a unit and must be replaced as such. Mann+Hummel recommends replacing the HEPA filter/UV lamp assembly every 12 months. The UV lamps are permanently mounted inside the HEPA filter frame. The UV lamps itself are not replaceable.

Warning: UV lamps get extremely hot during operation. Lamp must be "OFF" for at least 15 minutes before replacing the HEPA filter/UV lamp assembly to allow lamp to cool. Touching the lamp immediately after it is turned "OFF" will result in severe skin burns

1. Turn the unit OFF and unplug the power cord from the receptacle.
2. Disconnect any ducting from the unit and then carefully turn the machine upside down (onto its top) to gain access to the HEPA filter access panel (refer to the KEY COMPONENTS section at the beginning of the manual to locate the access panel). Be sure that the unit is secured so that it does not fall over during the HEPA filter change process.
3. Remove all of the Philips head screws located along the perimeter of the access panel (do not unscrew the casters from this panel) and remove the access panel from the machine.
4. Remove the nuts that secure the metal HEPA filter retaining bracket in place. Slide the bracket off the long filter retaining bolts and carefully remove the HEPA filter.

Note: UV lamps must be disposed of in accordance with federal, state, municipal, local and employer regulations. Contact the local waste disposal authority for instructions on the proper disposal of UV lamps.

5. Orient the new HEPA filter such that the foam seal is against the plate that separates the HEPA compartment and the motorized impeller compartment. Carefully place the HEPA filter in the unit so that it is centered and the foam gasket seals against the plate separating the HEPA compartment and the motorized impeller compartment.
6. Replace the HEPA filter retaining bracket over the threaded rods and replace the nuts to secure the HEPA filter. The nuts should be tightened to ensure the gasket seals the filter against the plate, but be sure not to overtighten them. If the unit is equipped with UV capability, reconnect the connector to the lamp located in the center of the cylindrical HEPA filter.
7. Reattach the access panel with the Philips screws and carefully turn the unit upright. Reconnect any ducting if necessary.

General Notes About Filters



Note: The filters are not reusable, therefore, do not attempt to clean and reuse them. Trying to clean filters with methods such as compressed air can cause damage to the filter and compromise the HEPA filter efficiency rating.

Caution: TRI-KLEEN portable air filtration units are designed to meet or exceed standards for high efficiency air filtration equipment. Use only Mann+Hummel parts, including replacement filters. **Use of non-original parts and filters voids the product warranty and all performance claims and**

jeopardize worker and environmental safety.

Warning: To reduce the risk of fire, electrical shock or personal injury, always turn the unit “OFF” and disconnect the power cord from supply receptacle before replacing the HEPA filter and before cleaning or servicing the unit.

COMPONENT REPLACEMENT AND CARE OF THE UNIT

Warning: To reduce the risk of fire, electrical shock or personal injury, always turn the unit “OFF” and disconnect power cord from supply receptacle before removing the control panel, replacing the HEPA filter and before cleaning or servicing the unit. This unit is equipped with an automatic restart motorized impeller that will restart without warning after a temporary power interruption or recovery from a thermal overload (over-heating) condition. Keep clear of the motorized impeller at all times to reduce the risk of injury.

Occasionally a defective component will cause the unit to operate improperly or not at all. Any electrical component can fail. Refer to the Wiring Diagrams and Wiring Schematics to diagnose the failure of any component. Diagnostics should only be performed by a technician qualified to service electrical equipment.

The unit should be cleaned with a damp cloth or a water-based cleaner/sanitizer. Do not use harsh chemicals, solvents or detergents to clean the unit.

Warning: Keep electrical components dry as their exposure to liquids poses a safety hazard and can damage components.

TRI-KLEEN 500UV BR SERIES SPECIFICATIONS

FEATURE	SPECIFICATION
Net weight with filters	25 kg
Shipping weight	31.8 kg
Unit's dimensions	W 16.25" x D 21.75" x H 37.75" (W 41.3 cm x D 55.2 cm x H 96 cm]

Power supply requirements	220 volts AC, 60 Hz, circuit of 15 amp. 110 volts AC, 60 Hz, 15 amp. (Optional)	
Max current draw	2.5 amps	
Automatic restart	The unit will automatically restart itself after temporary power interruption.	
Control panel	LCD touch screen controls.	
Fuse	Integrated fuse of 5 amp.	
Air flow ratings *	Speed 1: 127 m ³ /h Speed 3: 536 m ³ /h	Speed 2: 225m ³ /h Speed 4: 705 m ³ /h
Power cord	(3 m) length, hardwired power cord.	
Sound level **	Speed 1: 45 dB Speed 3: 55.5 dB	Speed 2: 46.5 dB Speed 4: 72 dB
Pre-filter	Standard pre-filter: 2" (5 cm) deep pleated MERV8 pre-filter. Alternative pre-filter: 2" (5 cm) deep VAPOR-LOCK® pleated carbon filter for odor removal.	
HEPA Filter	Standard HEPA filter: cylindrical 99.97% efficient against 0.3µm particles at max airflow. Models TRI-KLEEN 500UV BR: Standard HEPA filter as specified above, but with UV lamp integrated into the filter	
Exhaust outlet	One exhaust grille located on top of unit. Exhaust grille dimensions: 12" x 8" (30.5 cm x 20.3 cm). Optional 8" nominal diameter (20.3 cm) exhaust collar available for connecting round ducting	

*Note: Airflow rating estimates are based on testing at 110 or 220VAC, 60Hz with an air straightener and a traverse of readings taken with a computing vane-anemometer. Actual results may vary for various reasons, including motor and blower and HEPA filter tolerances. Factors such as filter loading, reduced voltage to the motor, and inlet and outlet ducting will reduce airflow. Use the ratings as a general guideline only.

**Note: Sound levels measured at (3 m) from the unit with ambient noise of 34 dB.

TROUBLESHOOTING GUIDE

PROBLEM	POSSIBLE CAUSE	SOLUTION
No response when the power is turned on	Power cord unplugged.	Plug power cord firmly into electrical outlet in wall.

Defective power cord.	Check all connections and condition of cords. Do not operate with damaged power cord(s).
Tripped ground fault circuit interrupter (GFCI) or residual current device.	Reset GFCI/RCD at the power source.
Thermal overload on the motorized impeller has tripped.	Turn unit "OFF", wait 30 minutes and restart unit.

Note: If the unit does not start or malfunctions after carefully following the TROUBLESHOOTING GUIDE, please contact Mann+Hummel by means of the SAC (Customer Attendance Service) by phone 0-800-701-6266.

LIMITED WARRANTY

Mann+Hummel warrants that goods sold to the original user shall be free from defects in material and workmanship for a period of 1 year, except such as are commercially acceptable. This warranty does not include useful filter life. The warranty period for the lamps and ballasts is 1 year from the date of purchase. **Mann+Hummel does not warrant that the goods sold are merchantable or fit for any particular purpose. Mann+Hummel makes no warranties other than as stated in this paragraph. All other (given) warranties, guaranties (products), or representations, express or implied, by operation of law or otherwise, are expressly disclaimed.** Goods found to be defective or not to conform to specification of Mann+Hummel shall upon return be replaced or repaired, without any additional charges, or, as option, Mann+Hummel may refund the purchase price of such goods. Mann+Hummel will pay return transportation charges on returned goods not exceeding the transportation charges applicable to shipment from original destination unless the returned goods are free from defect and conform to specifications of Mann+Hummel. Returned goods which are found to be free from defect and to conform to specifications of Mann+Hummel shall be held for Purchaser's shipping instructions, which instructions Purchaser shall furnish promptly upon request. **Mann+Hummel liability shall in no event extend beyond replacement, repair or refund of the purchase price and Mann+Hummel shall not be liable under any circumstances for special, contingent or consequential damages, nor for loss, damages, or expenses directly or indirectly arising from the use of the goods, including without limitation, warehousing, labor, handling and service charges, die, equipment, or machine breakage, nor for costs, lost profits or loss of good will. The use of substitute parts and/or filters, which are not of Mann+Hummel voids all warranties and performance claims. The remedies set forth herein are exclusive.**

For warranty information and assistance, please contact Mann+Hummel by means of the SAC (Customer Attendance Service) by phone 0-800-701-6266.

TRI-KLEEN 500UV BR series high-efficiency air filtration units are originally equipped with true HEPA (High Efficiency Particulate Air) filters designed to maximize the performance of the equipment, and to meet the following industry standards:

ABNT NBR7256

Table 1 - Classification and essay methods for air filters

Filter class		Efficiency (%)
Coarse	G1	$50 \leq E_g < 65$
	G2	$65 \leq E_g < 80$
	G3	$80 \leq E_g < 90$
	G4	$90 \leq E_g$
Fine	F5	$40 \leq E_f < 60$
	F6	$60 \leq E_f < 80$
	F7	$80 \leq E_f < 90$
	F8	$90 \leq E_f < 95$
	F9	$95 \leq E_f$
Absolut	A1	$85 \leq E_{dop} < 94,9$
	A2	$95 \leq E_{dop} < 99,96$
	A3 (HEPA)	$99,97 \leq E_{dop}$
<p>NOTES:</p> <p>1. Fine and coarse filters:</p> <ul style="list-style-type: none"> - classified according to the EN 779:2002; - E_g = Gravimetric efficiency for synthetic powder standard Ashrae 52.1 Arrestance; - E_f - Particle efficiency of 0,4 μm <p>2. Absolute filters:</p> <ul style="list-style-type: none"> - E_{dop} - Efficiency for particles of 0,3 μm according to the standard U.S. Military Standard 282 (DOP Test) 		

100% Efficiency Tested

Mann+Hummel HEPA filters are individually tested and certified to ensure that the completed filter provides an overall minimum efficiency of 99.97% when challenged by a thermally generated test aerosol, 0.3-microns in size

TRI KLEEN 500UV SERIES PARTS LIST

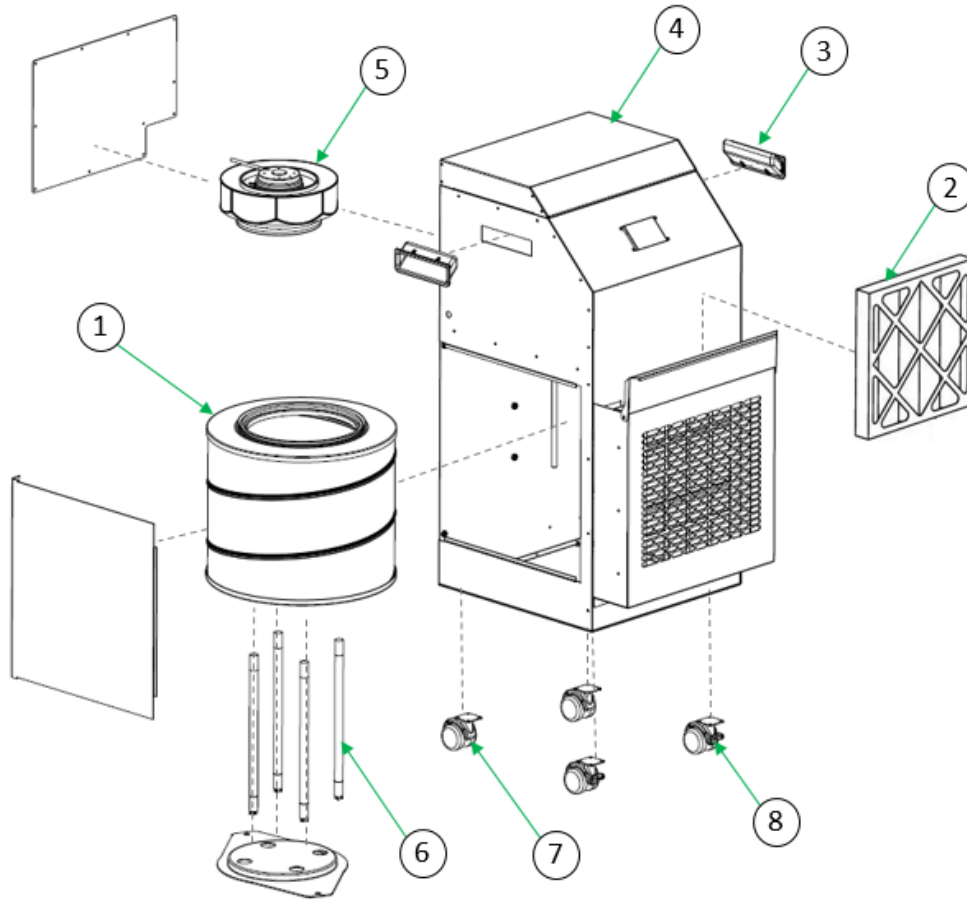

ITEM	CODE	DESCRIPTION	QUANTITY
1	14 379 78 S01	HEPA FILTER ELEMENT	1
2	14 381 79 S01	PRE-FILTER	1
3	14 380 42 S01	PLASTIC HANDLE	2
4	14 379 76 S01	METALLIC STRUCTURAL BODY	1
5	14 379 77 S01	MOTORIZED FAN / EXHAUSTER	1
6	14 381 12 S01	UV LAMP	4
7	14 380 41 S01	PLASTIC CASTER	2
8	14 381 93 S01	PLASTIC CASTER WITH LOCK	2
NOT VISIBLE IN EXPLODED VIEW			
	14 536 96 S01	CAPACITOR	1
	14 381 17 S01	POWER CORD	1
	14 381 13 S01	REACTOR	1

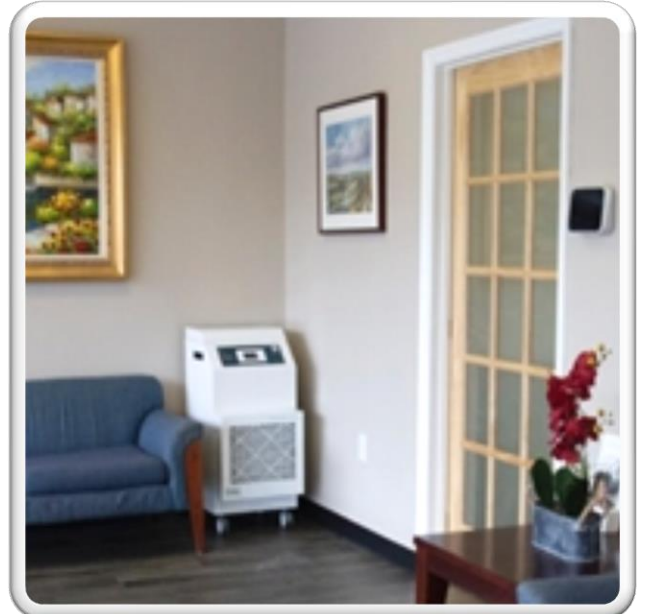
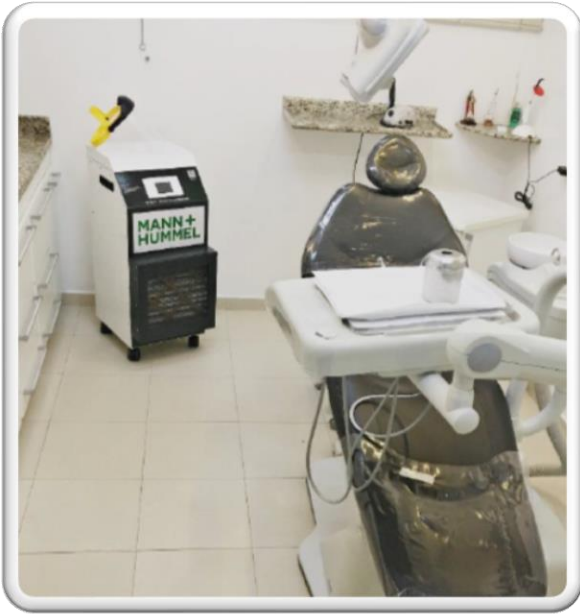

**MANN+
HUMMEL**